

# SUPPLY SERVICES LTD

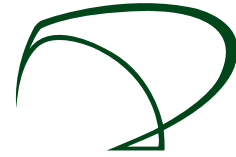

**CHAINS - SPROCKETS - PLASTICS - POWER TRANSMISSION**

## Northex™ UHMW - PE Chanex® Profiles

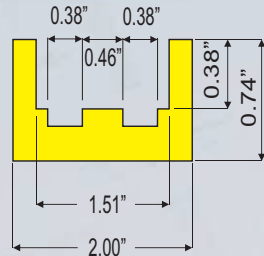

- CHP200/SC**  
 2" SCANNER TRANSFER CHANEX  
 - STOCKED IN 20' LENGTHS  
 - STOCK COLOUR - YELLOW  
 - WELD WASHERS NOT APPLICABLE  
 - SUITABLE FOR 2060 CHAIN

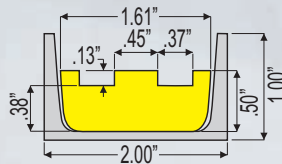

- CHP200CITT**  
 2" CHANNEL INSERT  
 - FITS IN 2" JUNIOR CHANNEL  
 - STOCK LENGTHS - (CALL)  
 - STOCK COLOUR - YELLOW  
 - SUITS 2060 CHAIN

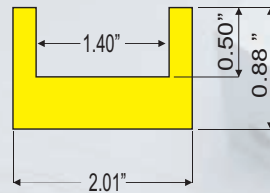

- CHP200**  
 2" STANDARD CHANEX  
 - STOCKED IN 20' LENGTHS  
 - STOCK COLOUR - YELLOW  
 - SMALL WELD WASHERS RECOMMENDED  
 - SUITABLE FOR RC80, 2080, 2060 CHAIN

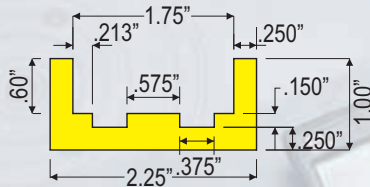

- CHP225TT**  
 2 1/4" CHANEX  
 - STOCKED IN 10' LENGTHS  
 - STOCK COLOUR - YELLOW  
 - FITS 2080 & 2080H CHAIN  
 - WELD WASHERS NOT RECOMMENDED

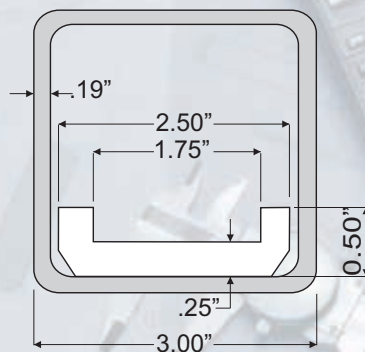

- CHP50250/B**  
 2 1/2" LOW WALL CHANEX  
 - STOCKED IN 10' LENGTHS  
 - STOCK COLOUR - WHITE  
 - WELD WASHERS NOT APPLICABLE  
 - FITS INSIDE 3/16" WALL 3" BOX TUBE  
 - CUSTOM LENGTHS AVAILABLE, CALL FOR PRICE & DELIVERY, MINIMUMS MAY APPLY

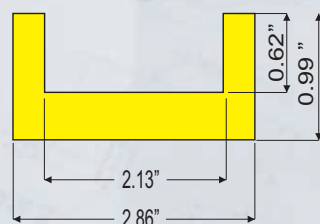

- CHP250**  
 2 1/2" STANDARD CHANEX  
 - STOCKED IN 20' LENGTHS  
 - STOCK COLOUR - YELLOW  
 - SMALL WELD WASHERS RECOMMENDED  
 - SUITABLE FOR 81X CHAIN

# SUPPLY SERVICES LTD

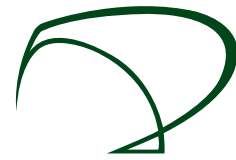

CHAINS - SPROCKETS - PLASTICS - POWER TRANSMISSION

## Northex™ UHMW - PE Chanex® Profiles

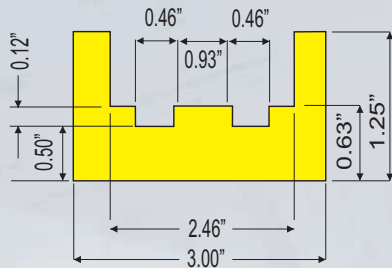

- CHP300TT**  
3" TRU-TRACK CHANEX  
- STOCKED IN 10' LENGTHS  
- STOCK COLOUR - YELLOW  
- WELD WASHERS NOT APPLICABLE  
- SUITABLE FOR 81X CHAIN

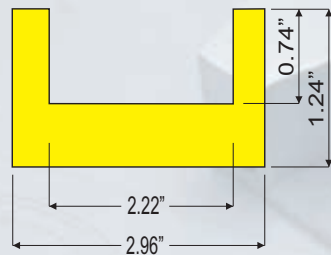

- CHP300**  
3" STANDARD CHANEX  
- STOCKED IN 20' LENGTHS  
- STOCK COLOUR - YELLOW  
- LARGE WELD WASHERS RECOMMENDED  
- SUITABLE FOR 81-X CHAIN

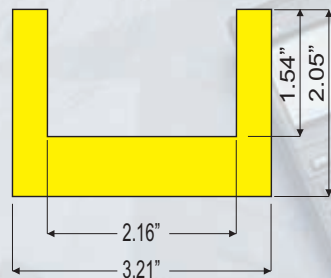

- CHP300HW**  
3" HIGH WALL CHANEX  
- STOCKED IN 20' LENGTHS  
- STOCK COLOUR - YELLOW  
- LARGE WELD WASHERS RECOMMENDED  
- SUITABLE FOR 81X CHAIN

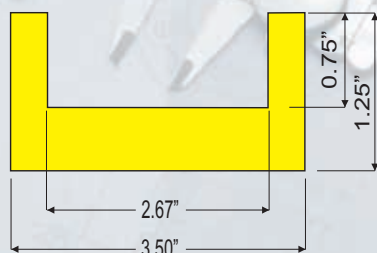

- CHP350125**  
3½" STANDARD CHANEX  
- STOCKED IN 20' LENGTHS  
- STOCK COLOUR - YELLOW  
- LARGE WELD WASHERS RECOMMENDED  
- SUITABLE FOR HD-81X CHAIN

# SUPPLY SERVICES LTD

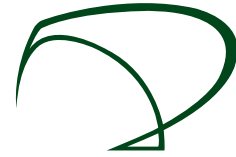

CHAINS - SPROCKETS - PLASTICS - POWER TRANSMISSION

## Northex™ UHMW - PE Chanex® Profiles

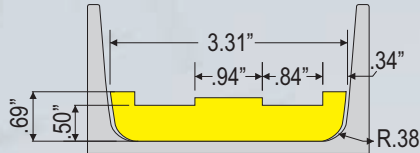

- #CHP400CITT  
TRU-TRACK CHANNEL INSERT  
- STOCK IN 10' LENGTHS  
- FITS 81X, 81XHD, H78  
- STOCK COLOUR - YELLOW  
- FITS IN C4X5.4 CHANNEL

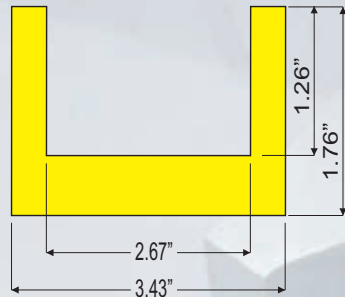

- CHP337  
3 3/8" HIGH WALL CHANEX  
- STOCKED IN 20' LENGTHS  
- STOCK COLOUR - YELLOW  
- LARGE WELD WASHERS ARE RECOMMENDED  
- SUITABLE FOR HD-81X CHAIN

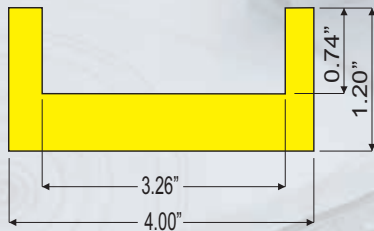

- CHP400  
4" STANDARD CHANEX  
- STOCKED IN 20' LENGTHS  
- STOCK COLOUR - YELLOW  
- LARGE WELD WASHERS ARE RECOMMENDED  
- SUITABLE FOR H78, H78A, H78B CHAIN

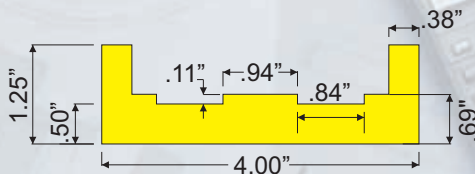

- CHP400TT  
4" TRU-TRACK CHANEX  
- STOCKED IN 10' LENGTHS  
- STOCK COLOUR - YELLOW  
- C/S SCREWS RECOMMENDED FOR FASTENING  
- SUITABLE 81X, 81XH, 81XHD, H78 CHAIN

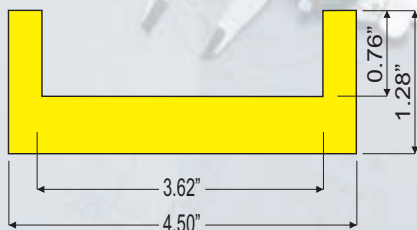

- CHP450  
4 1/2" HEAVY DUTY CHANEX  
- STOCKED IN 20' LENGTHS  
- STOCK COLOUR - YELLOW  
- LARGE WELD WASHERS ARE RECOMMENDED  
- SUITABLE FOR HD78, H82 CHAIN

# SUPPLY SERVICES LTD

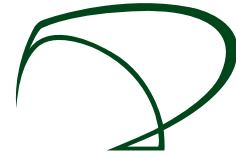

CHAINS - SPROCKETS - PLASTICS - POWER TRANSMISSION

## Northex™ UHMW - PE Chanex® Profiles

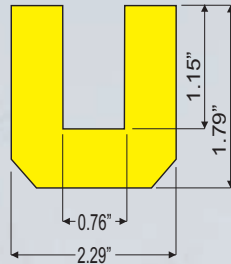

- CHP225175  
2¼" HIGH WALL  
- STOCKED IN 20' LENGTHS  
- STOCK COLOUR - YELLOW  
- ALSO REFERRED TO AS "BIN SLIDE"

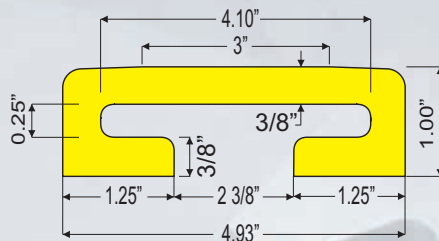

- FCP25400  
FLANGE CAP  
- CALL FOR LENGTH INFORMATION  
- STOCK COLOUR - YELLOW  
- SLIPS OVER W8 X 10 WIDE FLANGE  
- INSTALLED ON BIN SORTER KNEES and WALLS  
(See page #34 for further details)

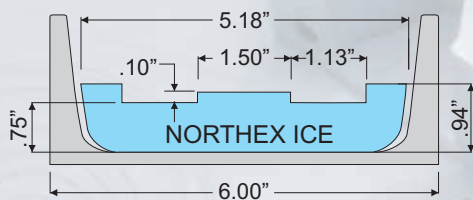

- CHP600CITT  
6" CHANNEL INSERT  
- FITS IN C6X8.2 CHANNEL  
- STOCK LENGTHS (CALL FOR AVAILABILITY)  
- AVAILABLE IN NORTHEX ICE  
- LARGE WELD WASHERS ARE RECOMMENDED  
- SUITABLE FOR H124 CHAIN

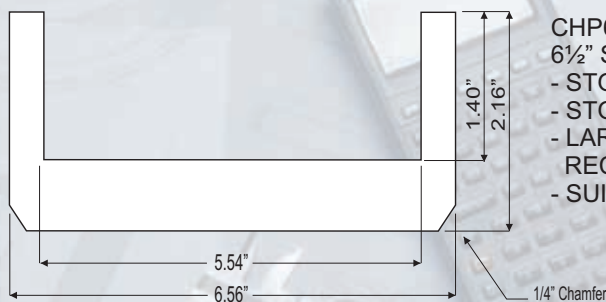

- CHP650  
6½" STANDARD CHANEX  
- STOCKED IN 10' LENGTHS  
- STOCK COLOUR - WHITE  
- LARGE WELD WASHERS ARE RECOMMENDED  
- SUITABLE FOR H124 CHAIN

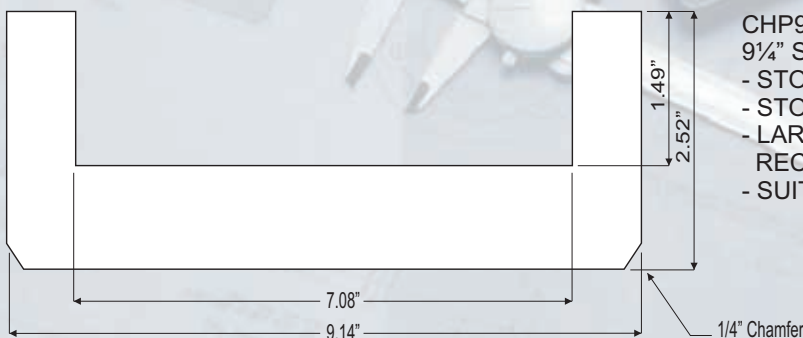

- CHP900  
9¼" STANDARD CHANEX  
- STOCKED IN 10' LENGTHS  
- STOCK COLOUR - WHITE  
- LARGE WELD WASHERS ARE RECOMMENDED  
- SUITABLE FOR H132 CHAIN